

NanoKnife

IRREVERSIBLE ELECTROPORATION



A UNIQUE ALTERNATIVE
TO THERMAL ABLATION



An ablation procedure that uses low energy electrical pulses to create defects (pores) in cell membranes, resulting in loss of homeostasis and subsequent cell death.

A NanoKnife* procedure is an ablation procedure that involves the delivery of a series of high voltage direct current electrical pulses between two electrodes placed within a target area of tissue. The electrical pulses produce an electric field which induces electroporation on cells within the target area. Electroporation is a technique in which an electrical field is applied to cells in order to increase the permeability of the cell membranes through the formation of nanoscale defects in the lipid bilayer. After delivering a sufficient number of high voltage pulses, the cells surrounding the electrodes will be irreversibly damaged. This mechanism which causes permanent cell damage is referred to as Irreversible Electroporation (IRE).

The NanoKnife System has been cleared by the FDA for the surgical ablation of soft tissue. It has not received clearance for the therapy or treatment of any specific disease or condition.

**Well Demarcated
Ablation Zones**

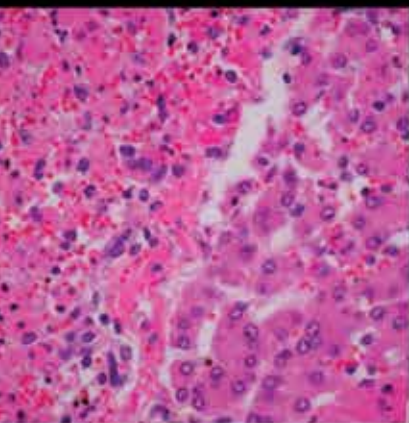

**Real-Time Visualization
via Ultrasound**



No Heat Sink Effect

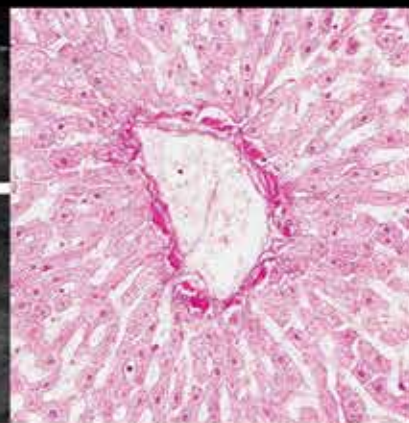

**Follow-up Visualization
via CT, MRI, or Ultrasound**

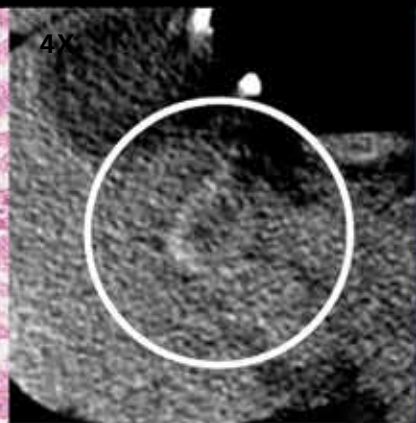

REFERENCES

- Lee EW, Chen C, et al. *Radiology*. 2010 May;255(2):426-33. doi: 10.1148/radiol.10090337.
- Lee EW, Wong D, et al. *J Vasc Interv Radiol*. 2012 Jan;23(1):107-13. doi: 10.1016/j.jvir.2011.09.020.
- Martin RCG 2nd. *Hepatobiliary Surg Nutr*. 2015 Jun; 4(3): 211–215. doi: 10.3978/j.issn.2304-3881.2015.01.10.
- Rubinsky B, Onik G, Mikus P. *Technol Cancer Res Treat*. 2007 Feb;6(1):37-48. doi: 10.1177/153303460700600106.
- Lee EW, Loh CT, Kee ST. *Technol Cancer Res Treat*. 2007 Aug;6(4):287-94. doi: 10.1177/153303460700600404.
- Lee EW, Thai S, Kee ST. *Gut Liver*. 2010 Sep; 4(Suppl 1): S99–S104. doi: 10.5009/gnl.2010.4.S1.S99.
- Ben-David E, Appelbaum L, et al. *AJR Am J Roentgenol*. 2012 Jan;198(1):W62-8. doi: 10.2214/AJR.11.6940.



SYSTEM COMPONENTS

- Touch screen monitor
- USB Port to export procedure data
- Keyboard and trackpad for data entry
- Up to 6 probes, minimum of 2 probes needed
- Side pockets for cables and foot pedal
- Double foot pedal to activate system
- Wheels to transport to and from storage location

Two Probe Array

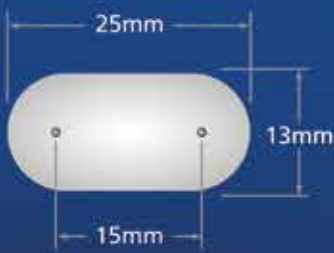

Three Probe Array

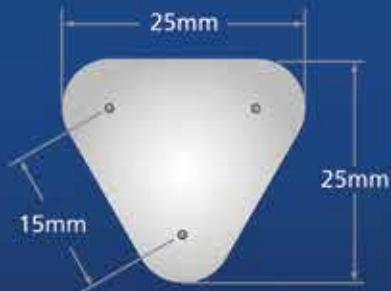

Four Probe Array

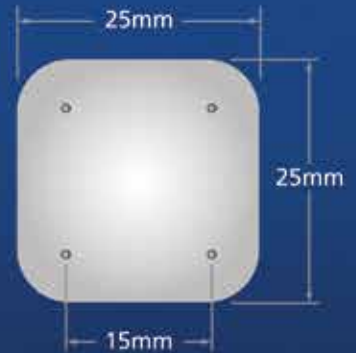

Procedure Information



Probe Selection



Probe Placement



Pulse Generation

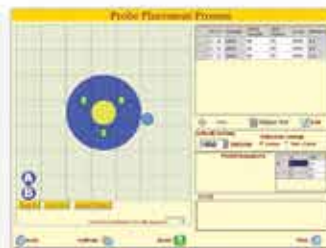

NANOKNIFE SYSTEM

SKU	DESCRIPTION
20300101	NanoKnife System v2.2.1 Includes: Generator, Foot Switch, ECG Synchronization Device, and 1-Year Warranty
H787204001070	NanoKnife Single Electrode Probe - 15 cm
H787204001080	NanoKnife Single Electrode Probe - 25 cm
H787204003015	NanoKnife Single Electrode Probe Spacers (Pack of 10)

INDICATIONS FOR USE:

FDA: The NanoKnife is intended for the surgical ablation of soft tissue in the United States. The FDA has not cleared the NanoKnife System for the treatment of any specific disease state or condition.

CONTRAINDICATIONS:

Ablation procedures using the NanoKnife System are contraindicated in the following cases: Ablation of lesions in the thoracic area in the presence of implanted cardiac pacemakers or defibrillators; Ablation of lesions in the vicinity of implanted electronic devices or implanted devices with metal parts; Ablation of lesions of the eyes, including the eyelids; Patient history of Epilepsy or Cardiac Arrhythmia; Recent history of Myocardial Infarction.

POTENTIAL ADVERSE EFFECTS:

Adverse effects that may be associated with the use of the NanoKnife system include, but are not limited to the following: Arrhythmia; Pneumothorax; Muscle contraction; Hemorrhage; Unintended mechanical perforation; Infection; Bradycardia; Vagal Stimulation, asystole; and damage to critical anatomical structure (nerve, vessel, and/or duct). Indications, contraindications, warnings, precautions and instructions for use can be found in the Instructions for Use supplied with each device. Observe all instructions prior to use. Failure to do so may result in patient complications.

Please refer to the NanoKnife System User Manual and the NanoKnife Single Electrode Probe Directions For Use for complete instructions, warnings and precautions.

CAUTION: Federal Law (USA) restricts this device to sale by or use under the order of a physician.



USA > 14 Plaza Drive, Latham, NY 12110 > tel: 800-772-6446 or 518-798-1215 > fax: 518-798-1360
International > Haaksbergweg 75 (Margrietoren), 1101 BR, Amsterdam Z-O > The Netherlands
tel: +31 (0)20 753 2949 > fax: +31 (0)20 753 2939

www.angiodynamics.com

*AngioDynamics, the AngioDynamics logo, NanoKnife and the NanoKnife logo are trademarks and/or registered trademarks of AngioDynamics, Inc., an affiliate or a subsidiary. © 2017 AngioDynamics, Inc. ANGB 338 US Rev 01